

# RVH8512

UNDERMOUNT WORKSTATION SINK

# RUVATI®

SPECIFICATION SHEET

## MATERIAL

True 16 Gauge Thickness  
Premium T304 Grade Stainless Steel  
18/10 Chromium/Nickel Content  
Commercial Brushed Finish

## FEATURES

- Heavy duty sound guard padding and undercoating
- Patent-Pending Glass Sink
- Single-Tier Ledge for Accessories

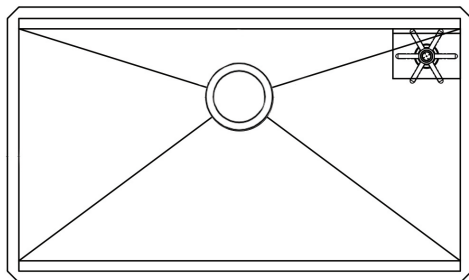

## IN THE BOX

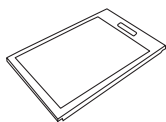

Cutting Board  
[RVA1217BWC]

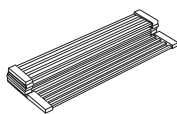

Folding Rack  
[RVA1395]

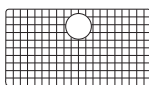

Rinse Grid  
[RVA68300]



Cut-out  
Template



Basket Strainer  
[RVA1025]



Drain Cover  
[RVA1035]

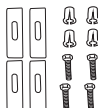

Mounting Clips  
[RVA11031]



Flex Hose  
[RVA11025]

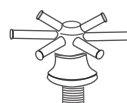

Sprayer Assembly  
[RVA11026]

## NOMINAL DIMENSIONS

Exterior: 32" (wide) x 19" (front-to-back)  
Interior Bowl: 30-3/8" (wide) x 16" (front-to-back)  
Bowl Depth: 10"  
Minimum Cabinet Size: 35" wide  
Drain Hole Size: 3 1/2"

Installation Type:  
Undermount

Inside Corners:  
Zero Radius

Drain Location:  
Rear Center

# RUVATI USA

www.ruvati.com

Phone: 1.855.478.8284  
Email: support@ruvati.com

# OPTIONAL ACCESSORIES (SOLD SEPARATELY)



Deep Basket Disposal Flange  
[RVA1049ST]

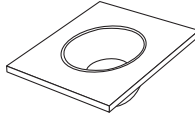

Mixing Bowl and Platform  
[RVA1288]

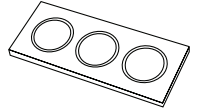

Condiment Serving Tray  
[RVA1377]

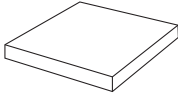

Butcher Block  
[RVA2445ACA]

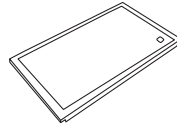

Black Plastic Cutting Board  
[RVA1217BLK]

## DIMENSIONS

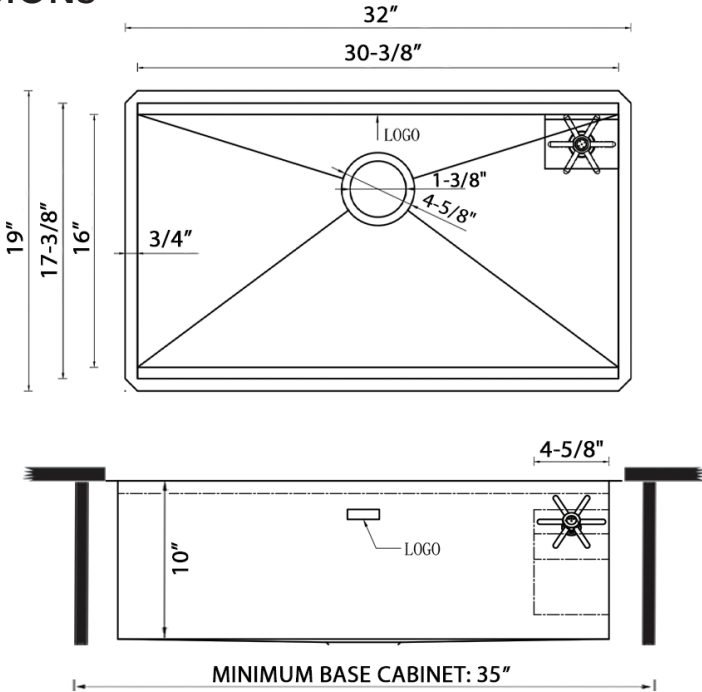

Register your product at [www.ruvati.com/register](http://www.ruvati.com/register).